

# Data Sheet



Article number: 021500700072

Description: Sealing Clamp S 72 W5

## Measures

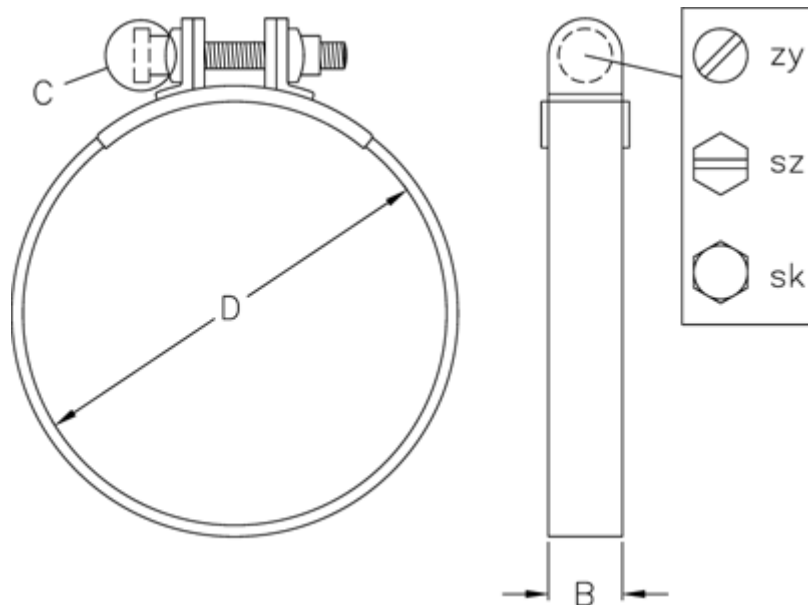

C (screw type) = SZ

Diameter D = 72

Width B = 20